

PROTECTION PRODUCTS - RailClamp®

Description

RailClamp® TVS arrays are ultra low capacitance ESD protection devices designed to protect high speed data interfaces. This series has been specifically designed to protect sensitive components which are connected to high-speed data and transmission lines from overvoltage caused by ESD (electrostatic discharge), CDE (Cable Discharge Events), and EFT (electrical fast transients).

The RClamp®0501T has a maximum capacitance of only 1.5pF. This allows it to be used on circuits operating in excess of 100MHz without signal attenuation. They may be used to meet the ESD immunity requirements of IEC 61000-4-2.

The RClamp0501T is in a 2-pin SLP1006P2T package measuring 1.0 x 0.6 x 0.4mm. The leads are spaced at a pitch of 0.65mm and feature a lead-free finish. Each device will protect one high-speed line operating at 5 volts. It gives the designer the flexibility to protect single lines in applications where arrays are not practical. The combination of small size, low capacitance, and high ESD surge capability makes them ideal for protection of high speed digital lines in cellular handsets and other portable electronic devices.

Features

- ◆ Transient protection for data lines to **IEC 61000-4-2 (ESD) ±25kV (air), ±20kV (contact) IEC 61000-4-4 (EFT) 40A (tp = 5/50ns) Cable Discharge Event (CDE)**
- ◆ Ultra-small package (1.0 x 0.6 x 0.4mm)
- ◆ Protects one data or I/O line
- ◆ Low capacitance: **1.5pF**
- ◆ Low clamping voltage
- ◆ Low operating voltage: 5.0V
- ◆ Solid-state silicon-avalanche technology

Mechanical Characteristics

- ◆ SLP1006P2T package
- ◆ Molding compound flammability rating: UL 94V-0
- ◆ Marking: Marking code
- ◆ Packaging: Tape and Reel
- ◆ Lead Finish: NiPdAu
- ◆ Pb-Free, Halogen Free, RoHS/WEEE Compliant

Applications

- ◆ Cellular Handsets & Accessories
- ◆ Multimedia Card Interfaces
- ◆ Digital Signal Lines
- ◆ SIM Ports
- ◆ Keypads
- ◆ SD Lines

Dimensions

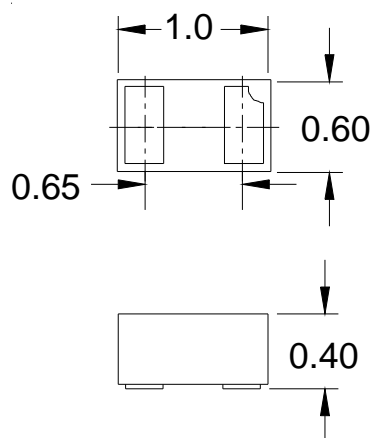

Maximum Dimensions (mm)

Schematic & PIN Configuration

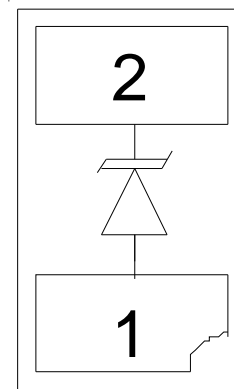

SLP1006P2T (Bottom View)

PROTECTION PRODUCTS
Absolute Maximum Rating

Rating	Symbol	Value	Units
Peak Pulse Power (tp = 8/20μs)	P_{pk}	150	Watts
Peak Pulse Current (tp = 8/20μs)	I_{pp}	10	A
ESD per IEC 61000-4-2 (Air) ESD per IEC 61000-4-2 (Contact)	V_{ESD}	+/- 25 +/- 20	kV
Operating Temperature	T_J	-55 to +125	°C
Storage Temperature	T_{STG}	-55 to +150	°C

Electrical Characteristics (T=25°C)

Parameter	Symbol	Conditions	Minimum	Typical	Maximum	Units
Reverse Stand-Off Voltage	V_{RWM}				5	V
Reverse Breakdown Voltage	V_{BR}	$I_t = 1mA$	6.9		9.7	V
Reverse Leakage Current	I_R	$V_{RWM} = 5V, T=25^\circ C$			0.100	μA
Clamping Voltage	V_C	$I_{pp} = 3A, tp = 8/20\mu s$ Pin 2 to 1			12	V
Clamping Voltage	V_C	$I_{pp} = 10A, tp = 8/20\mu s$ Pin 2 to 1			15	V
Forward Clamping Voltage	V_F	$I_{pp} = 3A, tp = 8/20\mu s$ Pin 1 to 2			4	V
Junction Capacitance	C_j	$V_R = 0V, f = 1MHz$ $T = 25^\circ C$	0.6		1.5	pF
Junction Capacitance	C_j	$V_R = 0V, f = 1MHz$ $T = 0 \text{ to } +85^\circ C$	0.5		1.7	pF

PROTECTION PRODUCTS

Typical Characteristics

Non-Repetitive Peak Pulse Power vs. Pulse Time

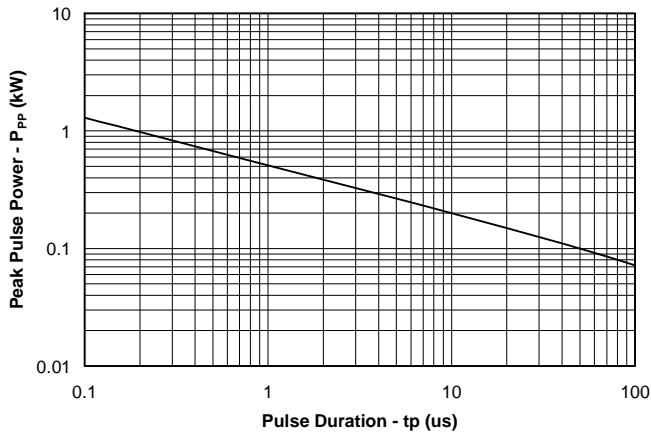

Clamping Voltage vs. Peak Pulse Current

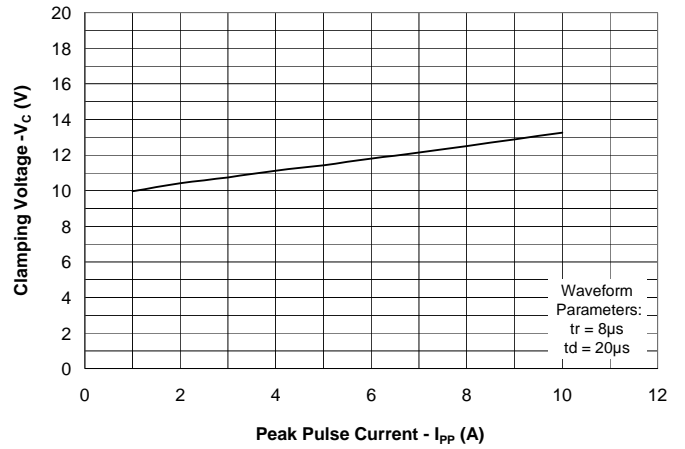

Forward Voltage vs. Peak Pulse Current

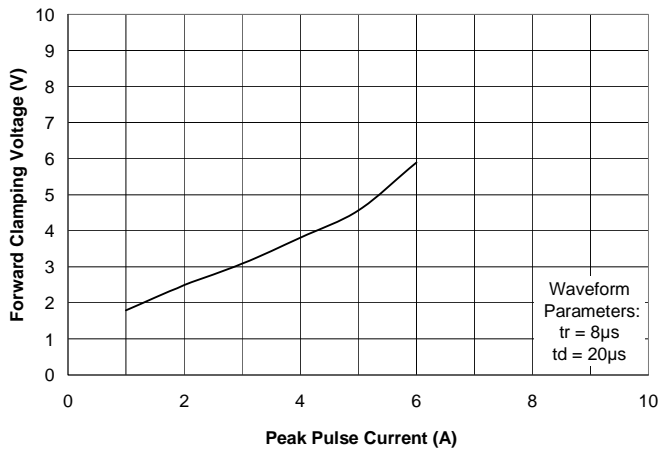

Normalized Capacitance vs. Reverse Voltage

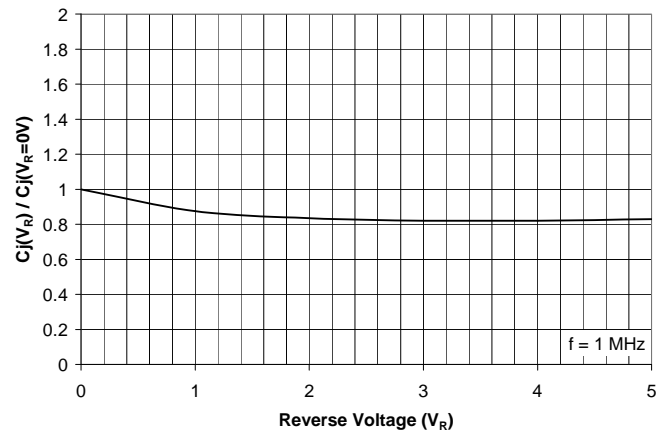

ESD Clamping

(8kV Contact per IEC 61000-4-2)

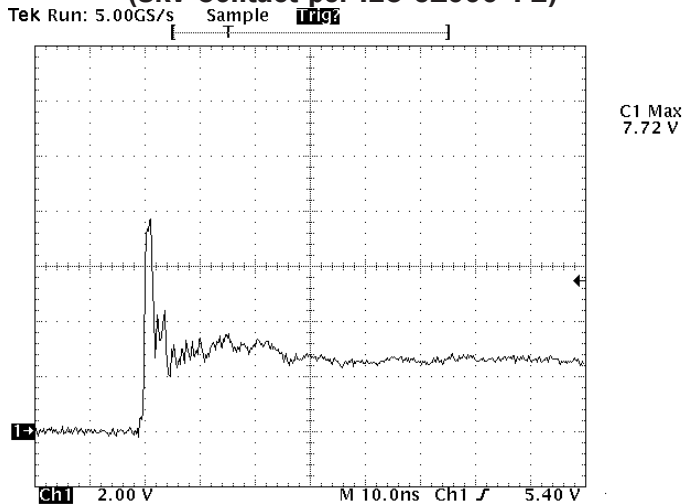

Insertion Loss S21

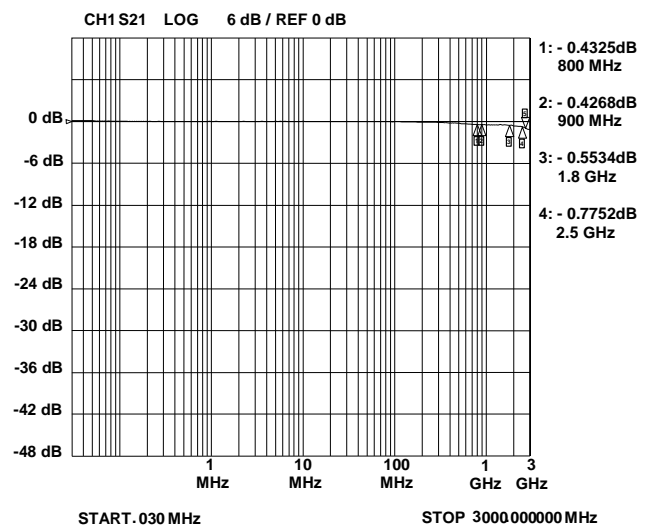

Note: Data is taken with a 10x attenuator

PROTECTION PRODUCTS**Applications Information****Device Connection Options**

These low capacitance TVS diodes are designed to provide common mode protection for one high-speed line. The device is unidirectional and may be used on lines where the signal polarity is positive.

Circuit Board Layout Recommendations for Suppression of ESD.

Good circuit board layout is critical for the suppression of ESD induced transients. The following guidelines are recommended:

- Place the TVS near the input terminals or connectors to restrict transient coupling.
- Minimize the path length between the TVS and the protected line.
- Minimize all conductive loops including power and ground loops.
- The ESD transient return path to ground should be kept as short as possible.
- Never run critical signals near board edges.
- Use ground planes whenever possible.

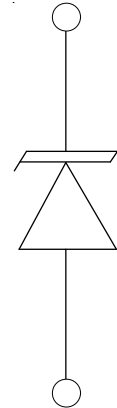
Equivalent Circuit Diagram

PROTECTION PRODUCTS

Outline Drawing - SLP1006P2T

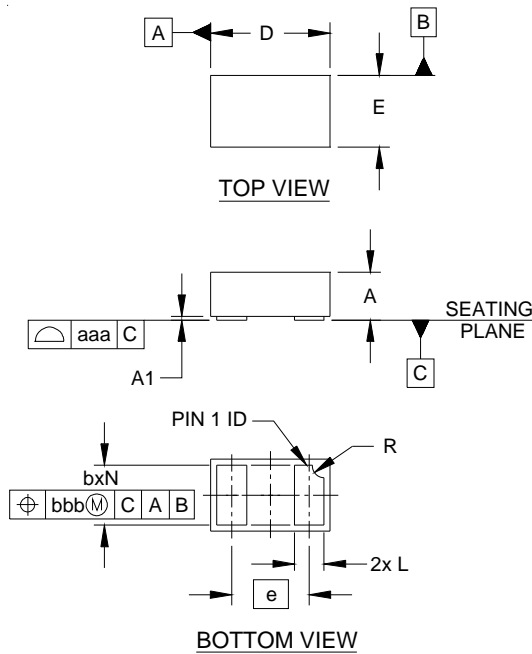

DIM	DIMENSIONS					
	INCHES			MILLIMETERS		
	MIN	NOM	MAX	MIN	NOM	MAX
A	.015	.016	.017	0.37	0.40	0.43
A1	.000	.001	.002	0.00	0.03	0.05
b	.018	.020	.022	0.45	0.50	0.55
D	.035	.039	.043	0.90	1.00	1.10
E	.020	.024	.028	0.50	0.60	0.70
e	.026 BSC			0.65 BSC		
L	.008	.010	.012	0.20	0.25	0.30
R	.002	.004	.006	0.05	0.10	0.15
N	2			2		
aaa	.003			0.08		
bbb	.004			0.10		

NOTES:

1. CONTROLLING DIMENSIONS ARE IN MILLIMETERS (ANGLES IN DEGREES).

Land Pattern - SLP1006P2T

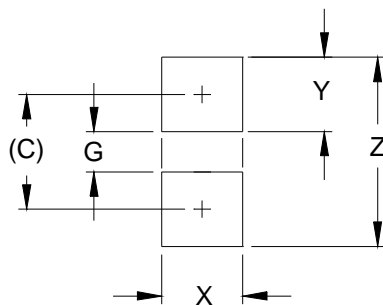

DIM	DIMENSIONS	
	INCHES	MILLIMETERS
C	(.033)	(0.85)
G	.012	0.30
X	.024	0.60
Y	.022	0.55
Z	.055	1.40

NOTES:

1. CONTROLLING DIMENSIONS ARE IN MILLIMETERS (ANGLES IN DEGREES).
2. THIS LAND PATTERN IS FOR REFERENCE PURPOSES ONLY. CONSULT YOUR MANUFACTURING GROUP TO ENSURE YOUR COMPANY'S MANUFACTURING GUIDELINES ARE MET.

PROTECTION PRODUCTS

Marking Code

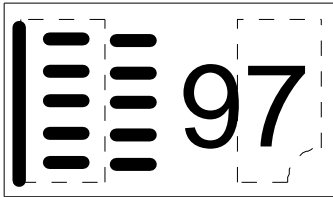

Ordering Information

Part Number	Qty per Reel	Reel Size
RClamp0501T.TNT	10,000	7 Inch

RailClamp and RClamp are trademarks of Semtech Corporation.

Notes:

1) Marking will also include line matrix date code

Carrier Tape Specification

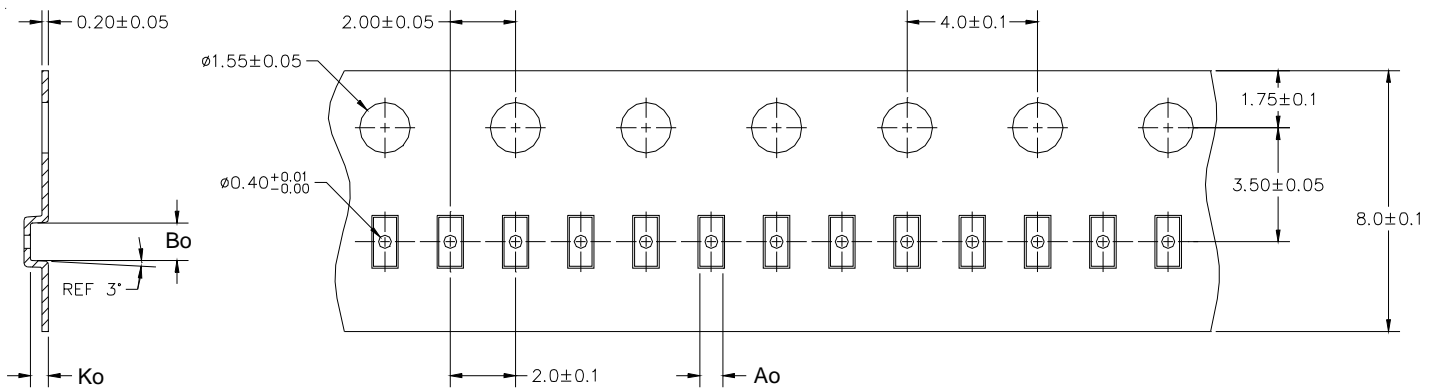

Device Orientation in Tape

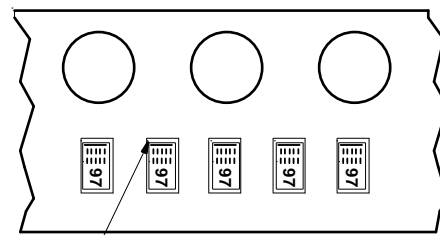

Pin 2 Cathode Location
(Towards Sprocket Holes)

A0	B0	K0
0.70 +/-0.05 mm	1.15 +/-0.05 mm	0.55 +/-0.05 mm

Note: All dimensions in mm unless otherwise specified

Contact Information

Semtech Corporation
 Protection Products Division
 200 Flynn Rd., Camarillo, CA 93012
 Phone: (805)498-2111 FAX (805)498-3804